

Η Ευρωπαϊκή Μεθοδολογία Διαχείρισης Έργων Ανασκόπηση, πλεονεκτήματα και φιλοσοφία της Μεθοδολογίας PM²

ΕΚΔΔΑ

11 Νοεμβρίου 2019, Αθήνα



Enabling better Project Management in Europe

Nicos Kourounakis, BSc, MASc, MBA,
PMP, IPMA-D, PRINCE2, Agile PM²



About this Presentation



- The PM² Story
- The PM² Advantage
- The PM² Future



Projects are not “a piece of cake...”



A variety of challenges related to:

- Initiating
- Planning
- Coordination
- Monitoring & Controlling
- Reporting
- Closing
- Benefits Realisation



Need better Project Management?

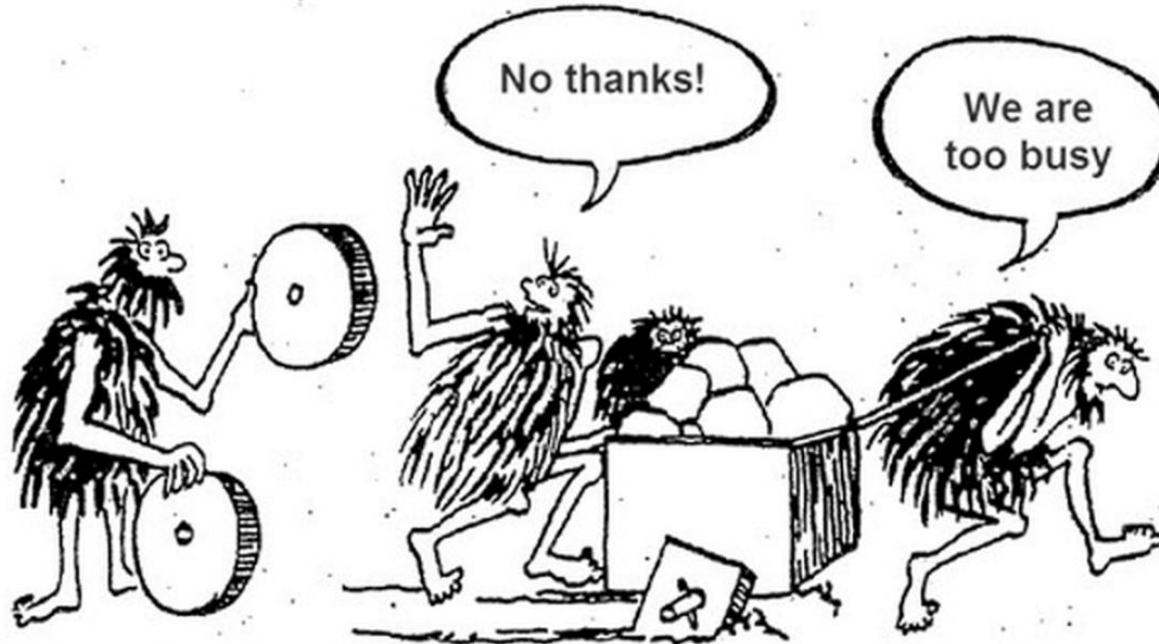



Project Management is our "weapon"



PM² is a *Project Management Methodology* developed and supported by the European Commission.

The purpose of PM² is to enable project teams to manage projects in an effective and efficient manner for the purpose of delivering **solutions and benefits** to their Organisations and their Stakeholders.



The PM² Methodology is there for you!

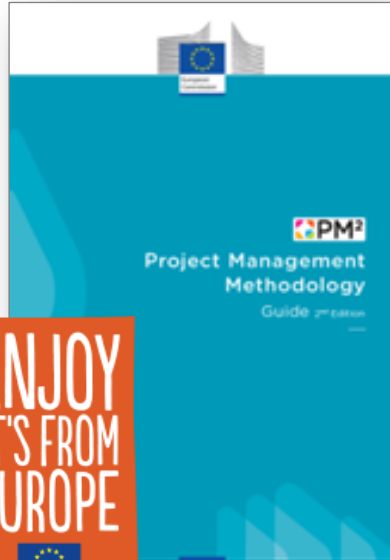

The PM² Project Management Methodology Guide

FREE TO DOWNLOAD FROM THE EU BOOKSHOP!

<https://webgate.ec.europa.eu/fpfis/wikis/display/openpm2>

<https://joinup.ec.europa.eu/community/opm2>



Challenges

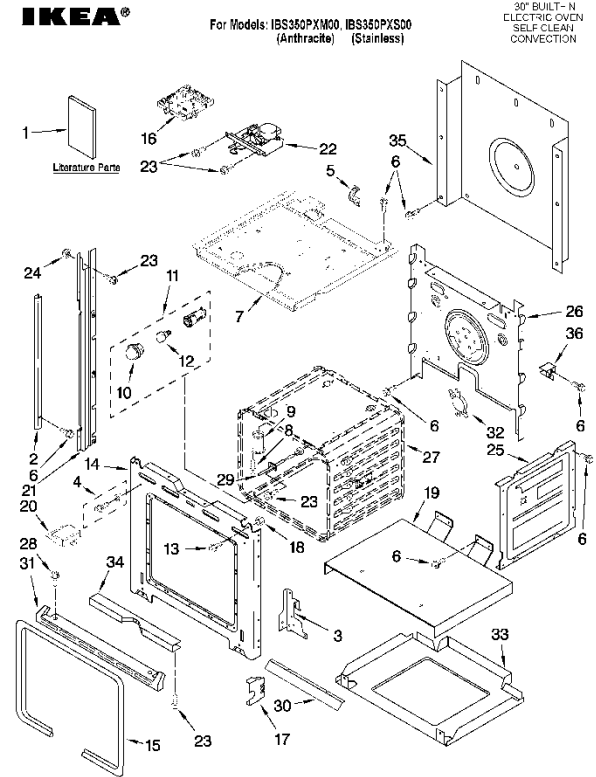

Guidelines on how to...

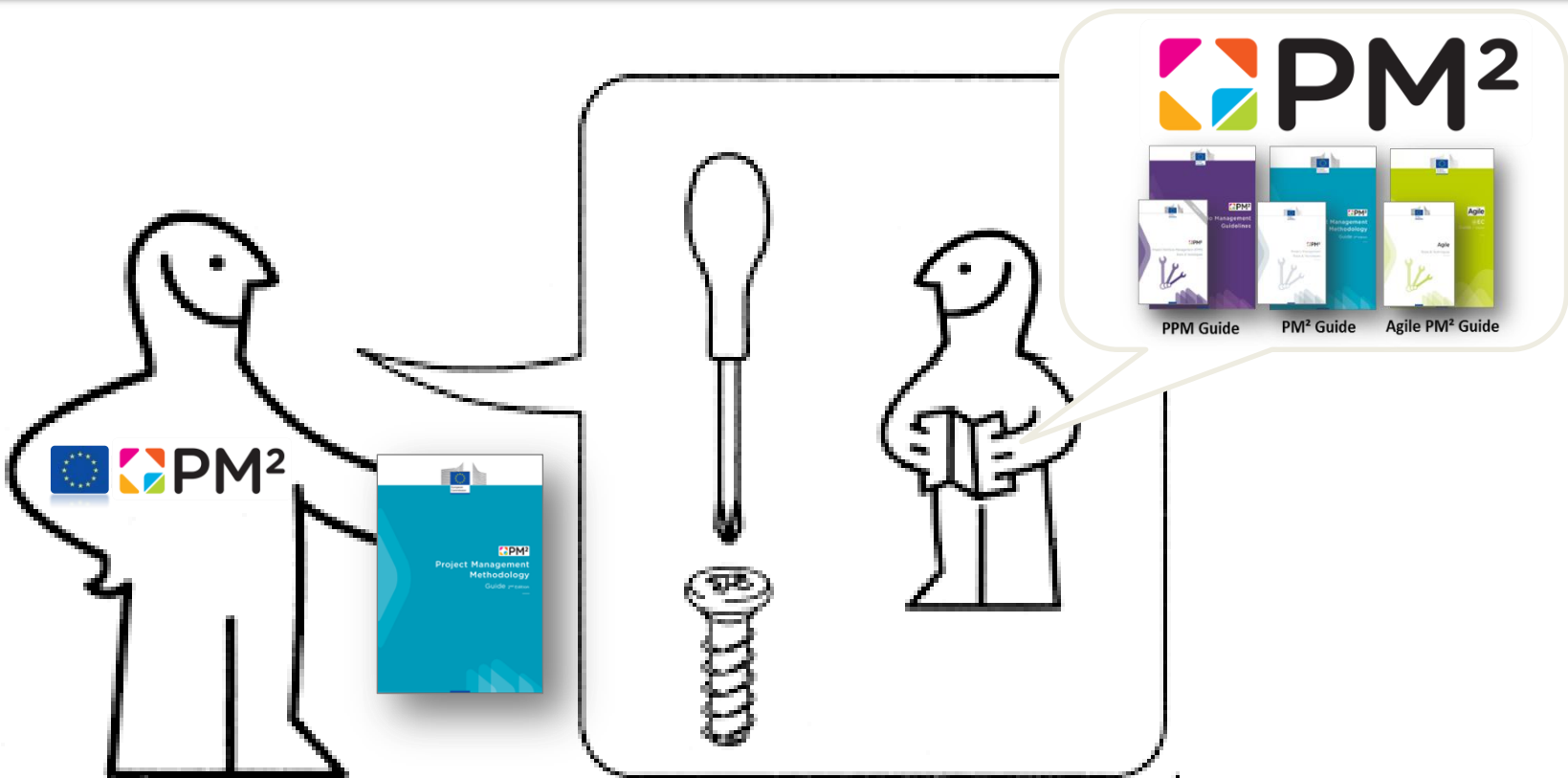

Where do we start?

The PM² Methodology helps us answer the important Project Management questions:

WHY?

- What (needs to be done)?
- When (do we need to do it)?
- Who (should do it)?
- How (much of it + how do we do it)?

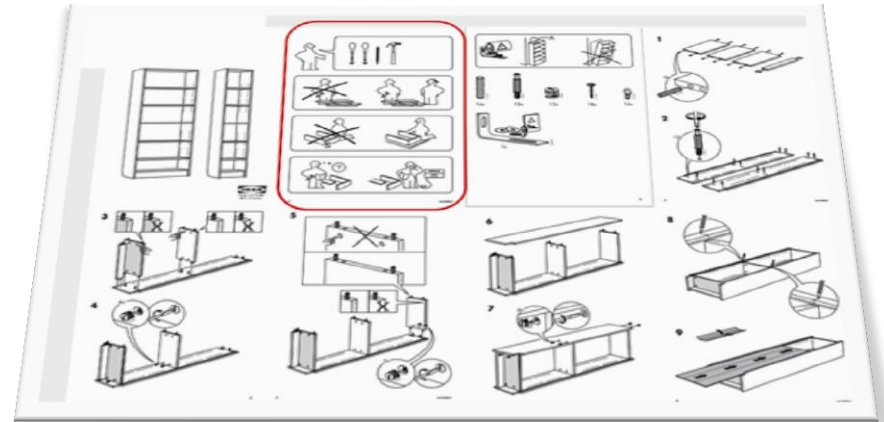

Free PM² Overview in 23 languages



- Čeština
- Dansk
- Deutsch
- Eesti
- English
- Español
- Français
- Hrvatski
- Italiano
- Latviešu
- Lietuvių
- Magyar
- Malti
- Nederlands
- Polski
- Português
- Română
- Slovenčina
- Slovenščina
- Suomi
- Svenska
- Ελληνικά
- Български
- РУССКИЙ



PM² - free and open source



Publications Office of the European Union

EUROPEA - Publications Office of the EU - Publication detail - PM² project management methodology

Home EU Publications

EU publications
PM² project management methodology
Guide 3.0

This guide sets out to provide an introduction to the PM² Project Management Methodology. It has been kept as lean as possible, while still providing enough information to allow for an effective understanding of the PM² Methodology as practitioners visit to use it.

Published: 2018-10-06
Corporate author(s): Directorate-General for Information (European Commission)
Personal author(s): Maraslis, Athanasios; Kourounakis, Nicos
Themes: Business organisation and management
Subject: Corporate Governance, EU Institution, guide, management techniques, project management, quality standard, terminology

	ISSN	ISBN	DOI	Catalogue number
PDF	978-92-79-91829-2	10.2799/755246	10.2799/755246	NO-01-18-851-EN-N
Paper	978-92-79-91915-2	10.2799/076039	10.2799/076039	NO-01-18-851-EN-C

A4: Pages: 00152 - Weight: 440.0 - Size: 7.6 x 297.0 x 210.0 MM
Available language(s): English

https://bookshop.europa.eu/en

EU Bookshop

Discover last month's 10 most downloaded publications!

PM² Project Management Methodology Guide
Open edition
Most popular download!

PM² is a Project Management Methodology developed and supported by the European Commission. Its purpose is to enable project teams to manage their ...

joinup

Share and reuse interoperability solutions for public administrations

Open Project Management Methodology

Initiative PM² is a Project Management Methodology developed and supported by the Commission to enable project teams to manage their projects effectively and deliver solutions to users and stakeholders. PM² is a light and easy to implement methodology suitable for any custom developed to fit the specific needs, culture and constraints of EU ...

<https://bookshop.europa.eu/en/pm-project-management-methodology-guide-pbNO0716056/>

<https://webgate.ec.europa.eu/fpfis/wikis/display/openpm2>
<http://europa.eu/!Gu76mr>

<https://joinup.ec.europa.eu/community/opm2>



PM² - Europe's Methodology



Open PM²
Project Management Methodology

Free Sharing
Common Vision Open Community
Collaboration Agile
Improvement Commitment
Knowledge Goals Values Success
Team Mindsets Best Practices
Communication Benefits Quality
Project PM² Management
Governance Outcomes
Efficiency Effectiveness

Enabling better Project Management
in the European Union

<http://europa.eu/!vh96rM>

Funded by the European Union





CoEPM²
Centre of Excellence in PM²
EC-PM²@ec.europa.eu
presents

"The future of project management depends on project managers coming together as an open community with a common vision."

Enabling better
Project Management in the EU

Learn | Share | Participate | Evolve

OpenPM² 2018
CONFERENCE

Brussels, Charlemagne | February 1 & 2

FIND OUT MORE
<http://europa.eu/!Dm39WB>

Sponsored by the ISA² programme and:

- European Commission
- Council of the European Union
- European Committee of the Regions
- EUROPEAN CENTRAL BANK EUROSYSTEM
- European Union EXTERNAL ACT



The future of project management depends on project managers coming together as an open community with a shared vision:

*One common
free and open
project management
methodology for Europe.*

PM² Info Days, Events, Conferences



Secure | <https://europa.eu/digitec/news/open-pm2/>



Speakers Programme Expo Gallery Practical **DIGITEC Newsletter**

Open PM² Methodology Guide climbing up the charts!



Open PM² is an updated version of the PM² Methodology developed and used by the Commission since 2007. It is

COEPM²
Centre of Excellence in PM²
EC-PM²@ec.europa.eu
presents

"The future of project management depends on project managers coming together as an open community with a common vision."

from globally



Enabling better Project Management in the EU

Learn | Share | Participate | Evolve

FIND OUT MORE
<http://europa.eu/Idm39WB>

Sponsored by the ISA² programme and:

- European Commission
- Ministry of Digital Governance
- Ministry of Economic Affairs
- Ministry of Infrastructure, Transport and Energy
- Ministry of National Education
- Ministry of Regional Development
- Ministry of Science, Research and Innovation
- Ministry of the Interior
- Ministry of Justice
- Ministry of Labour and Social Security
- Ministry of Maritime Affairs and Fisheries
- Ministry of Health
- Ministry of Agriculture, Rural Development and Food
- Ministry of Environment, Energy and Climate Change
- Ministry of Education and Religious Affairs
- Ministry of Foreign Affairs
- Ministry of Tourism
- Ministry of Culture and Sports
- Ministry of Veterans Affairs
- Ministry of Gender Equality and Human Rights
- Ministry of Digital Policy
- Ministry of Digital Economy and Society
- Ministry of Digital Transformation
- Ministry of Digital Governance
- Ministry of Digital Policy
- Ministry of Digital Economy and Society
- Ministry of Digital Transformation



ISA² MID-TERM CONFERENCE

Linking public administrations, businesses and citizens
29 November 2018 – Brussels
#ISA2CONF18

ISA² Programme @EU_isa2 ISA² Programme

- CAMSS: COMMON ASSESSMENT METHOD FOR TENDERS AND SPECIFICATIONS
- CPSV-AP
- LegIT
- PM² Open Project Management Methodology
- LegIT
- SEMIC: Semantic Interoperability Community
- providing data once-only.eu
- EU Budget as Linked Open Data
- joinup

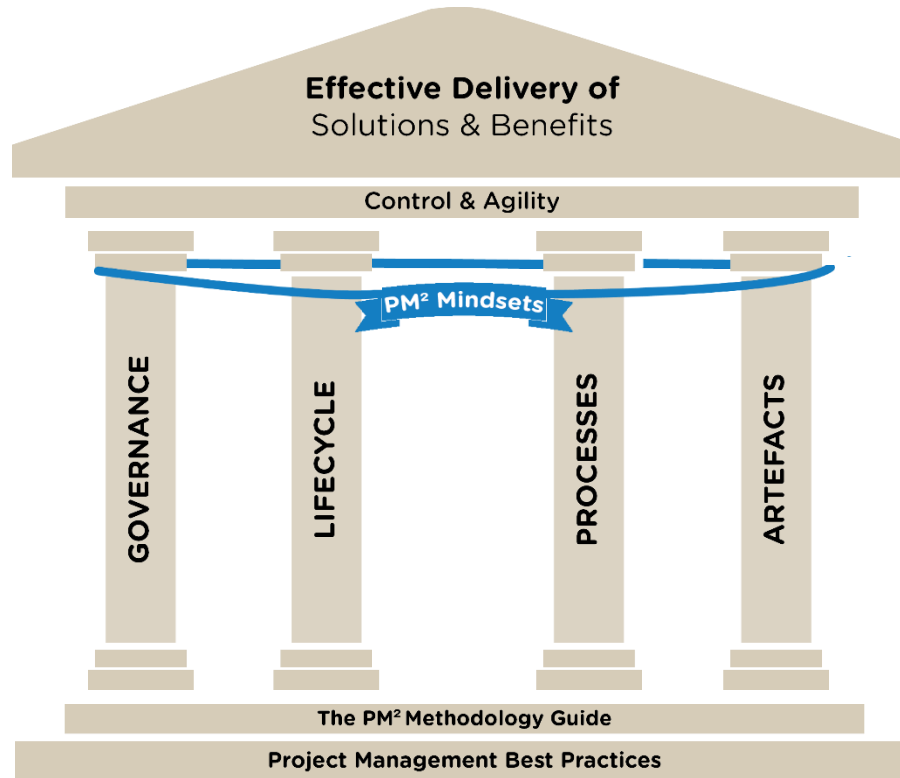

PM² Artefacts Landscape

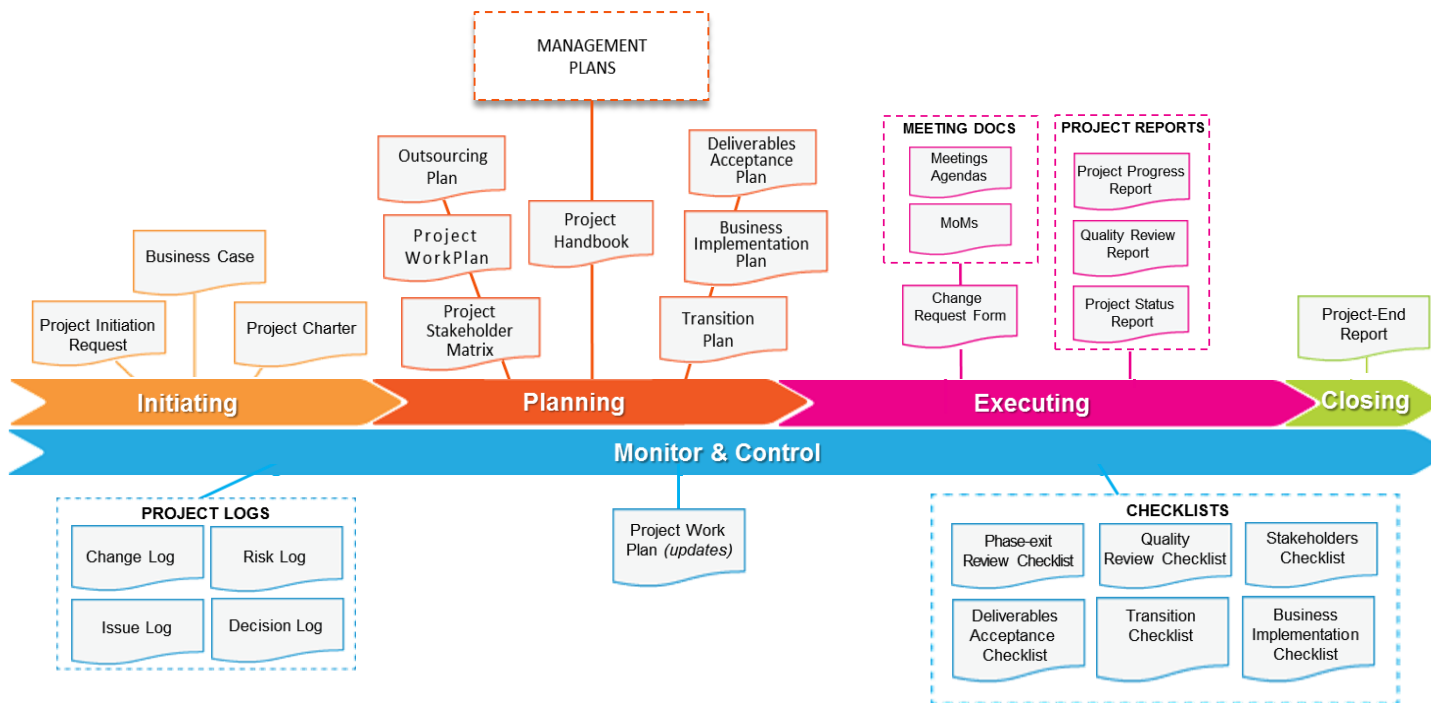

Einstein on Project Management...

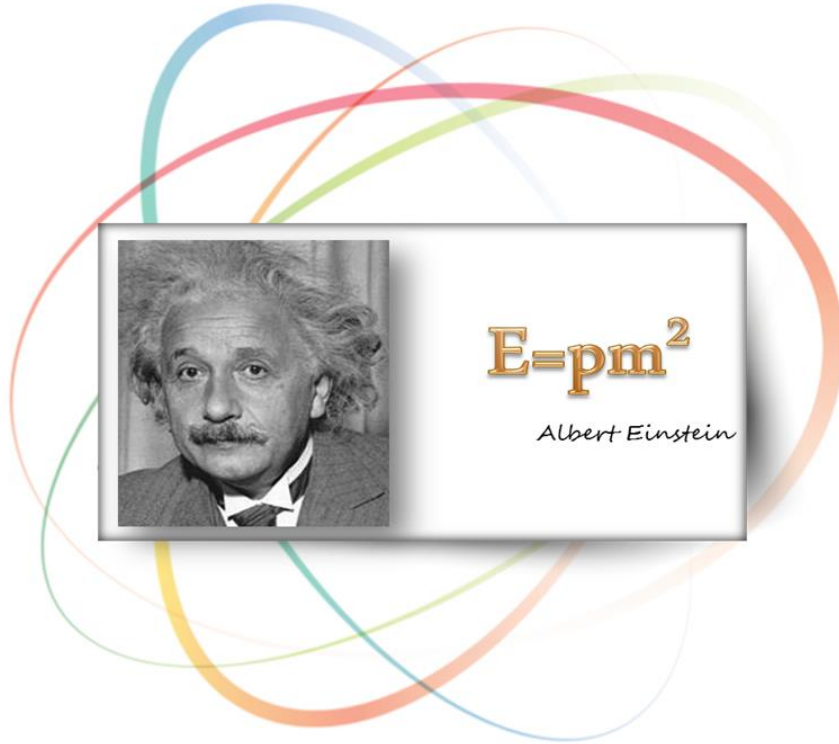

**INVEST
IN YOUR
PEOPLE**



The PM² Mindsets

PM² Processes & Mindsets



Download: <https://joinup.ec.europa.eu/collection/open-pm2-project-management-methodology/pm2-material>

PM² Mindsets

for project teams that practise PM²



**APPLY PM²
BEST
PRACTICES**
to manage their
project.

REMAIN MINDFUL

that methodologies are there to serve projects and not the other way around.



Foster a project culture of
COLLABORATION, clear
COMMUNICATION and
ACCOUNTABILITY.



OUTCOMES ORIENTATION

Maintain an Outcomes
Orientation in relation
to all projects and project
management activities.



BECOME COMMITTED

to delivering project
results with maximum
value rather than
just following plans.

Assign Project Roles
to the most appropriate
people for the benefit
of the project.

ASSIGN PROJECT ROLES



BALANCE

Balance in the most productive way
the project management "Ps" of:
product, process, plan, people,
pleasure/pain, participation,
perception and politics.

IMPROVE

Invest in developing their
technical and behavioural competences
to become better project contributors.



DRAW INSPIRATION



Draw inspiration from the
PM² Guidelines on Ethics and
Professional Virtues



**SHARE
KNOWLEDGE**
actively manage lessons
learned and contribute
to the improvement of
project management
within their organisations.

INVOLVE

Involve project
stakeholders in the
organisational change
needed to maximise
project benefits.



The PM² Mindsets

1. Don't get trapped in simply "serving" the methodology.



2. Shift your perspective and...

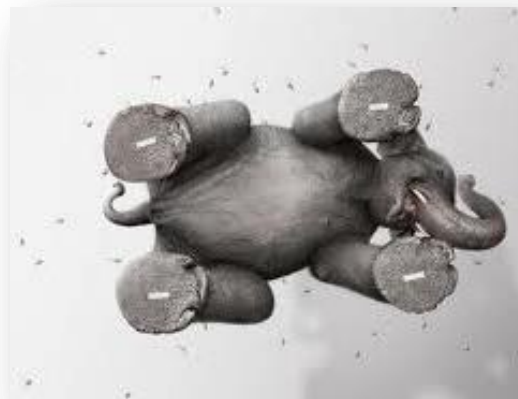

3. ...view your project work through the lenses of effective mindsets.



- The EU *spends* over **€ 959 988 million (2014-2020)**.
- The EU budget is divided into more than 80 funds and programmes (European Structural and Investments Funds (ESIF) representing 33% of the total budget).
- Around **6%** of the budget goes to the administration of the European institutions (**€ 57 599 M**) whereas around **94%** is allocated to various **European programmes** (€ 902 389 M).
- There are more than 100 authorities managing EU funds. **20% of these are managed directly** by the European Commission (**€ 180 478 M**). The remaining 80% are managed by other authorities.



The Story and the Future of PM²



Agile PM²

Certification

2012

PM² Trainings

PM² Guide v2

PM² wiki & CoP

IT Governance

Initiation



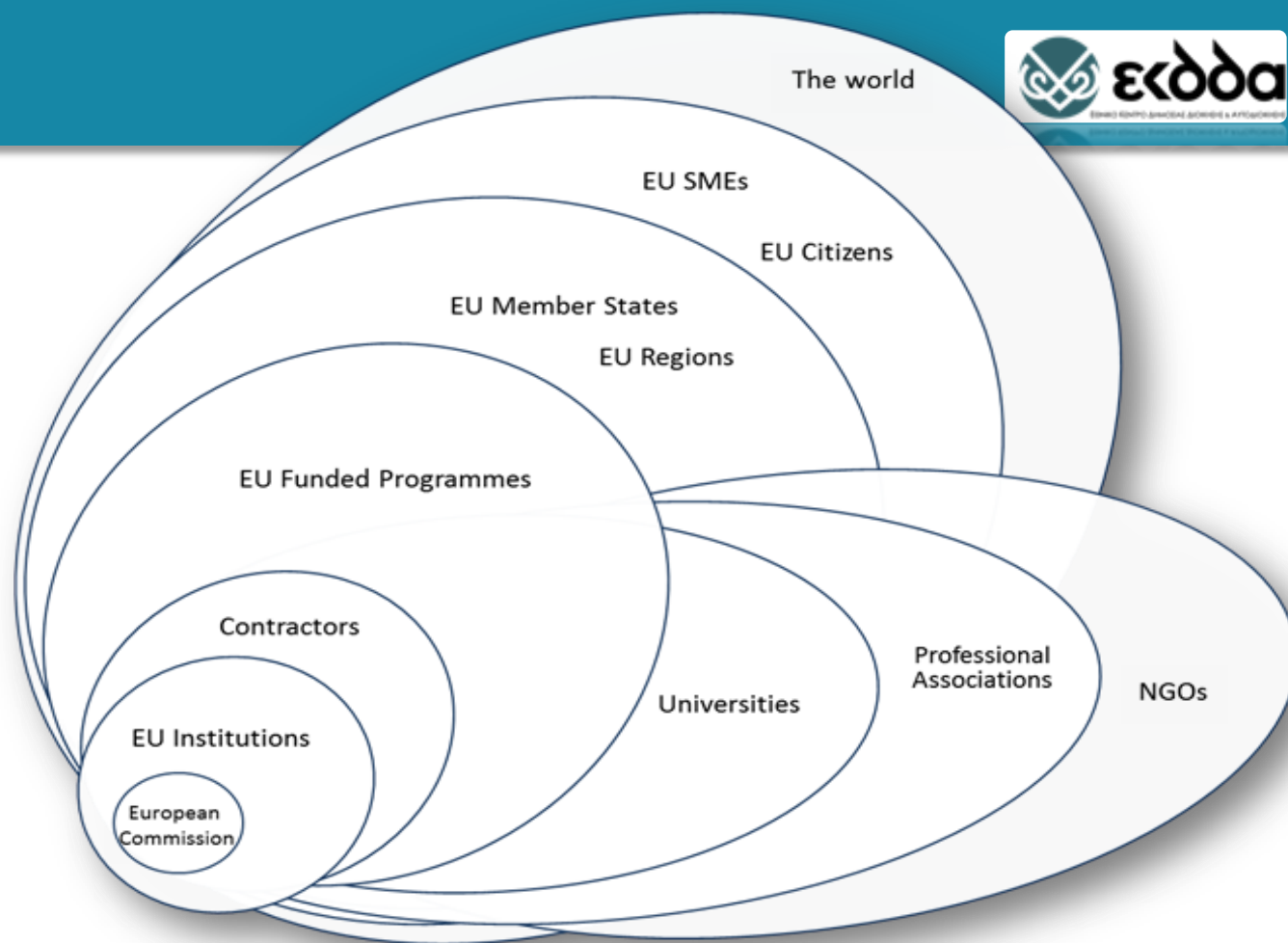



PM²
ALLIANCE



About the PM² ALLIANCE

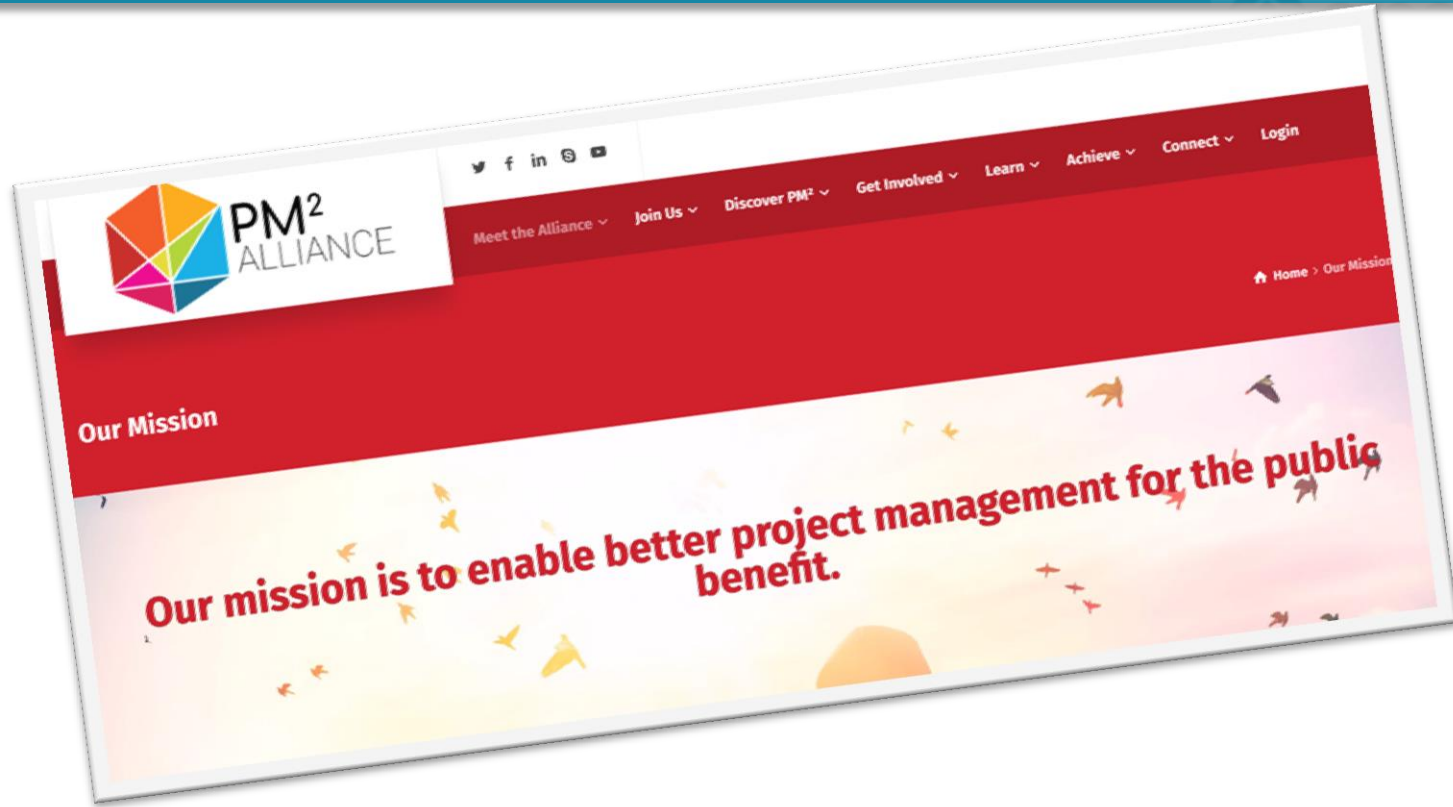

Learn more about the PM²
Alliance

The PM² ALLIANCE Vision

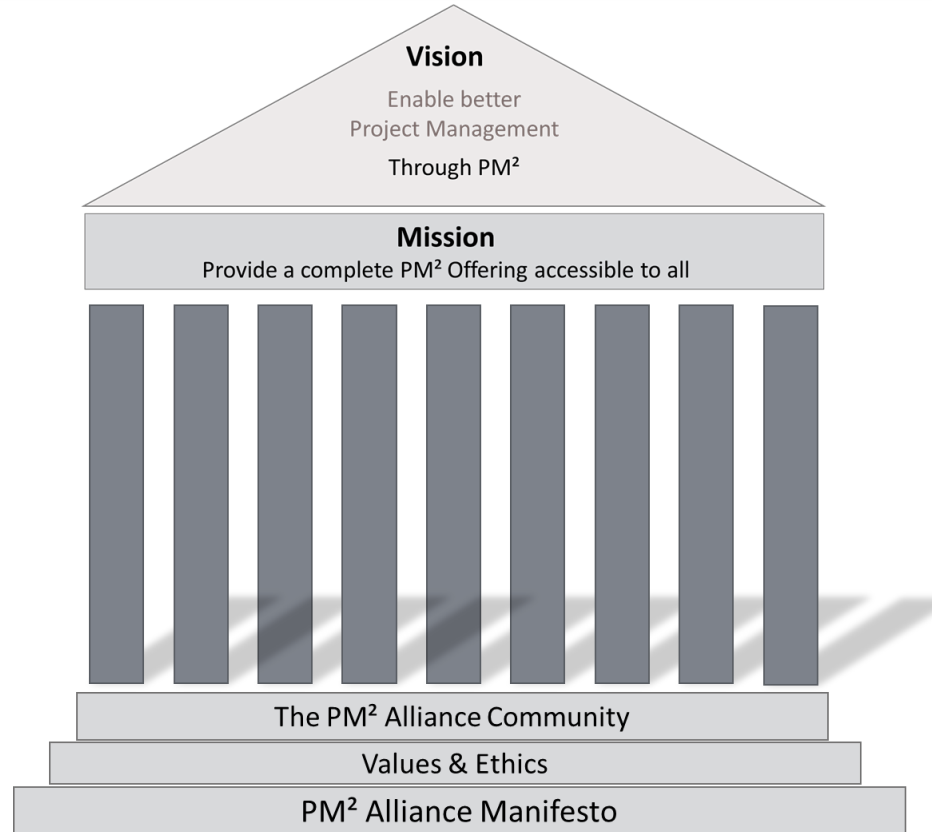

ONE METHODOLOGY – ONE COMMUNITY

We believe that the future of project management depends on the community of project managers working together, and that the PM² Alliance has a crucial role to play in enabling the sharing of knowledge and experiences and fostering appreciation of PM² as a common, open and free methodology for Europe – and beyond.



The PM² Alliance carries the torch of the Open PM² vision, promotes and evolves PM², and takes it to places “where no PM² has gone before”. It brings the Open PM² community together, connecting PM² practitioners, trainers, experts and project managers from all over Europe and works with other Institutions and organisations in promoting better project management in Europe.

**Together we
agree that the
time has
matured for the
adoption of a
common**

**project
language, a
common
project
methodology.**

THE PM² ALLIANCE:

DEVELOPS AND FOSTERS

excellence in Project Management

GENERATES

new ideas for a continual enhancement of project management mindsets and practices

CREATES AND DISSEMINATES

knowledge throughout its network

PROVIDES BENCHMARKING

tools for assessment and accreditation systems

EDUCATES

through a series of learning and development activities that foster learning and self-improvement

INFLUENCES

international governmental and non-governmental organisations through advocacy and lobbying

BUILTS LINKS

bringing peers together to exchange on latest developments and network

PROMOTES

the wider adoption of the PM² Methodology







Nicos Kourounakis

<https://www.PM2Alliance.eu/user/nicos.kourounakis>
<https://twitter.com/nkouroun>

1. Join the [PM² Alliance](#):
<https://www.pm2alliance.eu/membership-types/>
2. Read more about [Open PM²](#):
<https://www.linkedin.com/pulse/one-common-free-open-project-management-methodology-nicos-kourounakis/>
3. View videos and presentations from the [Open PM² Conference 2018](#):
<https://joinup.ec.europa.eu/collection/open-pm2-project-management-methodology/open-pm2-conference-2018-presentations>
4. Download the [Open PM² Handbook](#) from the EU Bookshop:
<https://publications.europa.eu/publication/ac3e118a-cb6e-11e8-9424-01aa75ed71a1>
5. Download the [Open PM² Templates](#):
<https://webgate.ec.europa.eu/efis/wikis/wiki/12/Artefacts>
6. Follow [Open PM² on Twitter](#):
<https://twitter.com/OpenPM2>
7. Find out more about [Open PM² Live](#) and join the [Open PM² Community](#):
<https://ec.europa.eu/isa2/solutions/open-pm2-live>
<https://joinup.ec.europa.eu/collection/open-pm2-project-management-methodology/open-pm2-conference-2018-presentations>



+ the PM² Alliance



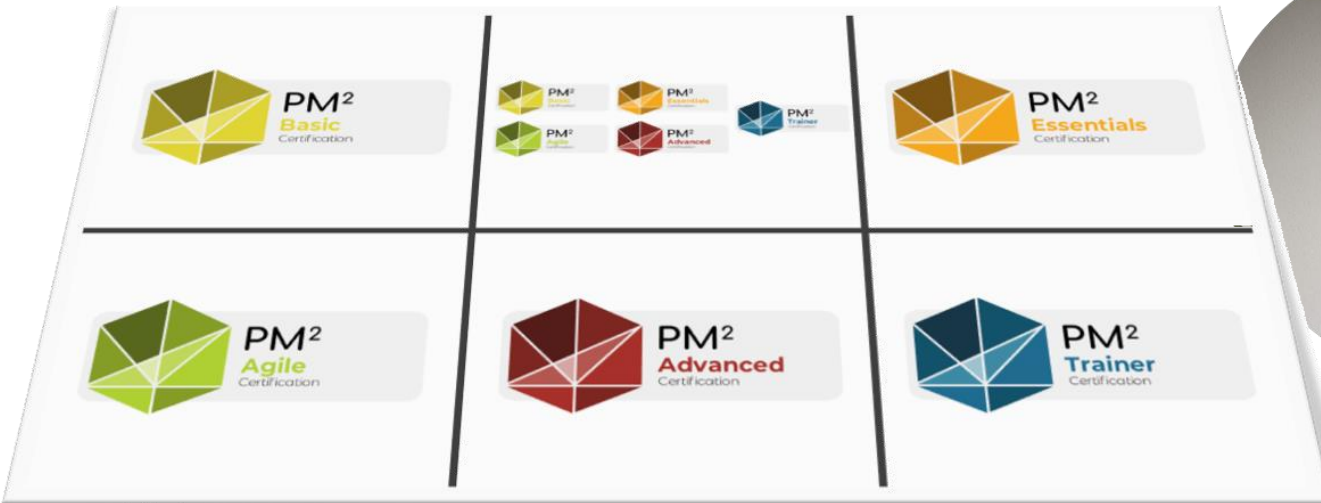

Available Certifications

Select the certification you are interested in for additional information



The PM² Alliance is committed to bringing the benefits of this certification to all EU Citizens for the purpose of the advancement of the PM² Methodology for the public good. The PM² Alliance Certification programme is **available to all** and has been designed to certify knowledge of the PM² methodology at various levels.

PM² Certification is ideal for

Individuals

Organisations

EU Funded Projects

Training Providers

<https://www.pm2alliance.eu/pm2-certification/>

PM² Alliance Regional Activities

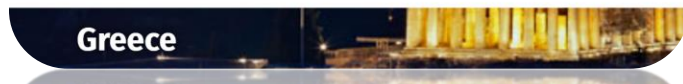

I've seen it before...

